

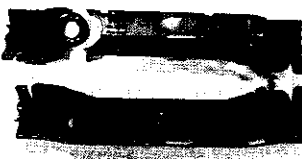









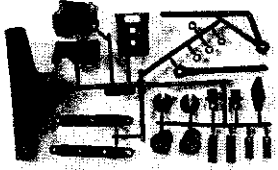
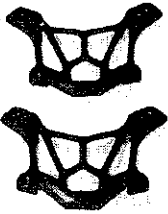
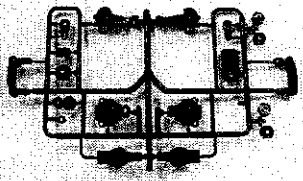

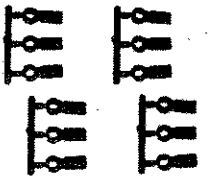

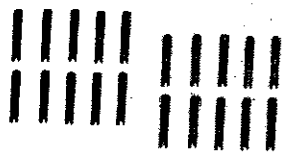
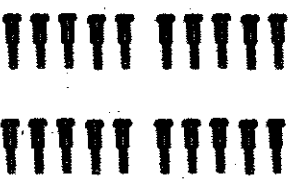
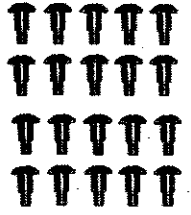
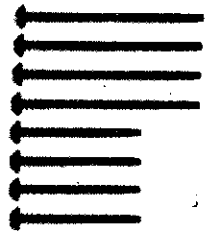

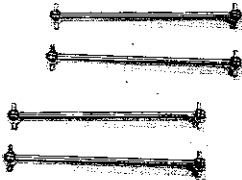
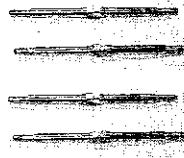

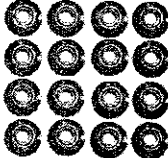
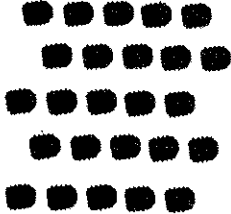
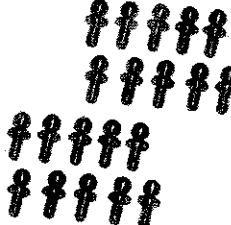
<p><b>1101</b></p>  <p>Chassis+Chassis Guard</p>	<p><b>51801</b></p>  <p>New Front Lower Arm(L/R)</p>	<p><b>51802</b></p>  <p>New Rear Lower Arm(L/R)</p>	<p><b>51803</b></p>  <p>Body Posts+Shock Assembly Units+ Servo Mount+Front/rear Upper Arm +Battery Guard Plate+Bumper (front or rear)</p>
<p><b>51804</b> MONSTER TRUCK ONLY</p>  <p>Monster Truck Front/Rear Shock Tower +Round Head Screw 3*14mm (4PCS)</p>	<p><b>51820</b></p>  <p>Front Uprights+Servo Mount Pad+Motor Pinion Guard+Rear Uprights+Gear Box Housing+Servo Saver+ Antenna Retainer +Servo Arm+Steering Hubs+Servo Saver Assembly Set B+Servo Saver Assembly Set A+Wheel Hex.</p>	<p><b>51821</b></p>  <p>Servo Saver Set</p>	<p><b>1203</b></p>  <p>Front Body Post *2 Rear Body Post *2</p>
<p><b>1204</b></p>  <p>Steering Linkage End 12PCS</p>	<p><b>2101</b></p>  <p>Centre Drive Shaft 5mm(Dia.)*250mm(L)</p>	<p><b>2102</b></p>  <p>Shaft Pin 5mm(Dia.)*20mm(L) 5mm(Dia.)*25mm(L) 5mm(Dia.)*30mm(L) 5mm(Dia.)*40mm(L)</p>	<p><b>2103</b></p>  <p>Wheel Hex.Pin 2mm(Dia.)*10mm(L) 20PCS</p>
<p><b>3101</b></p>  <p>Step Screw 3*14mm 20PCS</p>	<p><b>3102</b></p>  <p>Step Screw 4*11.5mm 20PCS</p>	<p><b>3103</b></p>  <p>Front Lower Arm Hinge Screw Rear Lower Arm Hinge Screw 4PCS+4PCS</p>	<p><b>3104</b></p>  <p>Front/rear Diff. Outdrive Cup (long+short) 2PCS+2PCS</p>

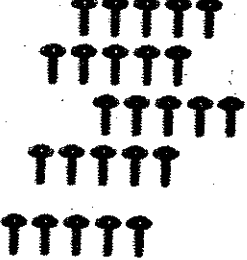
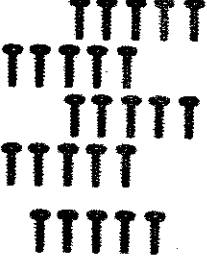
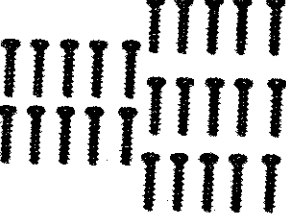
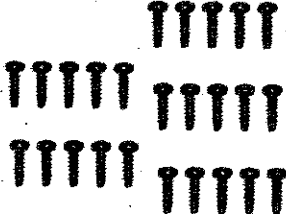
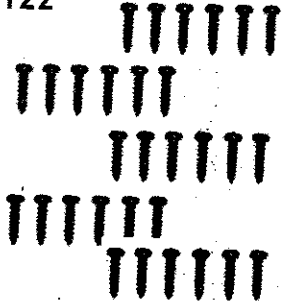
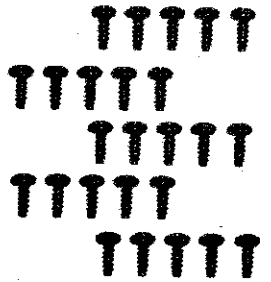
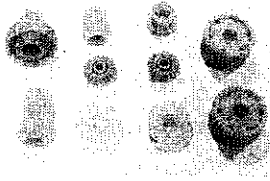
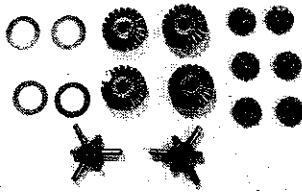
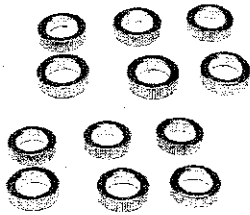
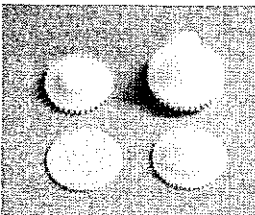

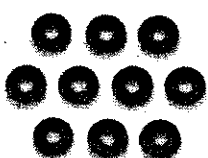
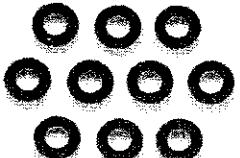

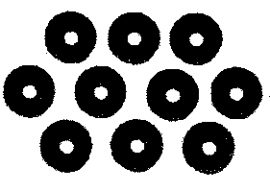
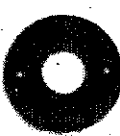
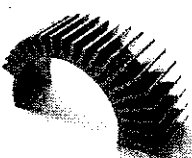

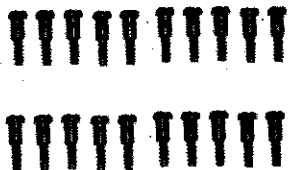
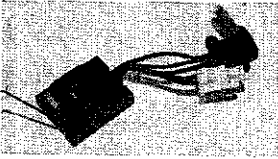
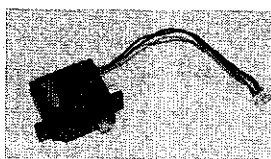
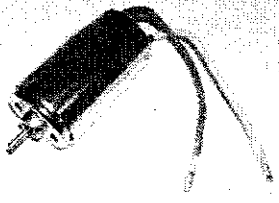
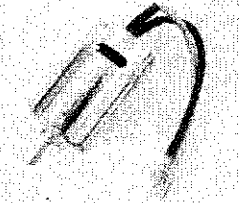

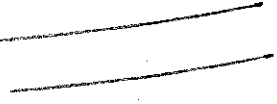

The images may vary from the actual received parts.

<p><b>3105</b></p>  <p>4PCS</p> <p>Front/Rear Wheel Axle</p>	<p><b>3107</b></p>  <p>6*77.3mm 4PCS</p> <p>Front/rear Drive Shaft</p>	<p><b>3109</b></p>  <p>3*71mm 4PCS</p> <p>Steering Linkage Bar</p>	<p><b>51805</b></p>  <p>12PCS</p> <p>Shock Screw Bolt 3*43mm</p>
<p><b>3114</b></p>  <p>16PCS</p> <p>Flange Lock Nut M4</p>	<p><b>3115</b></p>  <p>50PCS</p> <p>Grub Screw 3*3</p>	<p><b>3116</b></p>  <p>20PCS</p> <p>Steering Linkage Ball Stud</p>	<p><b>3117</b></p>  <p>20PCS</p> <p>( to install motor) Round Head Screw 3*25mm</p>
<p><b>3118</b></p>  <p>50PCS</p> <p>Flange Self Tapping Screw 3*10mm</p>	<p><b>3119</b></p>  <p>50PCS</p> <p>Big Round Head Self Tapping Screw 3*10mm</p>	<p><b>3120</b></p>  <p>50PCS</p> <p>Small Round Head Self Tapping Screw 3*10mm</p>	<p><b>3121</b></p>  <p>50PCS</p> <p>Round Head Self Tapping Screw 2.6*10mm</p>
<p><b>3122</b></p>  <p>50PCS</p> <p>Round Head Self Tapping Screw 2*8mm</p>	<p><b>3124</b></p>  <p>50PCS</p> <p>Round Head Self Tapping Screw 3*8mm</p>	<p><b>4101</b></p>  <p>Gears Complete</p>	<p><b>4102</b></p>  <p>Diff. Bevel Gears+ Star Shafts +Shim</p>

The images may vary from the actual received parts.

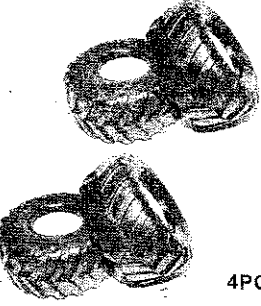
<p><b>21116</b></p>  <p>Brass Bushes (5*11*4) 12P</p>	<p><b>4104</b></p>  <p>2PCS Motor Pinion Gear (19T) + Set Screw</p>	<p><b>5101</b></p>  <p>Servo Gears</p>	<p><b>55802</b> OFF ROAD BUGGY ONLY</p>  <p>Off Road BuggyWing Stay(L/R) +Optional Body Post</p>
<p><b>5103</b></p>  <p>50PCS O-ring (3mm)</p>	<p><b>5104</b></p>  <p>50PCS O-ring (5mm)</p>	<p><b>5105</b></p>  <p>1M Silicon Tubing</p>	<p><b>5107</b></p>  <p>20PCS Black Body Post Pad</p>
<p><b>5108</b></p>  <p>20PCS Motor Pad</p>	<p><b>6101</b></p>  <p>Motor Sink Heat</p>	<p><b>6103</b></p>  <p>(Small) 12pcs + (big) 12pcs Clip</p>	<p><b>51808</b></p>  <p>20PCS Step Screw 3*16mm</p>
<p><b>21111</b></p>  <p>3-IN-1 PCB Unit</p>	<p><b>21112</b></p>  <p>Steering Servo (5 plugs)</p>	<p><b>8103</b> MONSTER TRUCK ONLY</p>  <p>RC 550L Motor</p>	<p><b>8104</b> OFF ROAD BUGGY ONLY</p>  <p>RC 550 Motor</p>

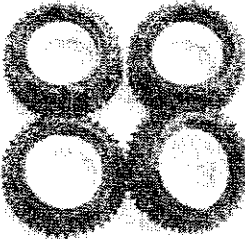
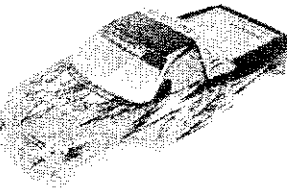
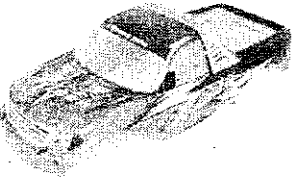

The images may vary from the actual received parts.

<p><b>P019</b></p>  <p><b>2PCS</b></p> <p>Receiver Antenna Pipe</p>	<p><b>21115</b></p>  <p>Ni-MH 1800 Battery</p>	<p><b>E020</b></p>  <p>For Battery 7.2v-7.4v</p> <p>Charger (America Standard)</p>	<p><b>E021</b></p>  <p>For Battery 7.2v-7.4v</p> <p>Charger (Europe Standard)</p>
<p><b>E022</b></p>  <p>For Battery 7.2v-7.4v</p> <p>Charger (Australia Standard)</p>	<p><b>E023</b></p>  <p>For Battery 7.2v-7.4v</p> <p>Charger (UK Standard)</p>	<p><b>51807</b></p> <p><b>MONSTER TRUCK ONLY</b></p>  <p>Front/rear Shock Set (Monster truck)</p>	<p><b>51850</b></p> <p><b>OFF ROAD BUGGY ONLY</b></p>  <p>Front/rear Shock Set (Off Road Buggy)</p>
<p><b>6518P-P001</b></p> <p><b>MONSTER TRUCK ONLY</b></p>  <p><b>4PCS</b></p> <p>Truck Tires+Sponge</p>	<p><b>7203</b></p> <p><b>MONSTER TRUCK ONLY</b></p>  <p><b>4PCS</b></p> <p>Off Road Chrome Plate Rims</p>	<p><b>7103</b></p> <p><b>OFF ROAD BUGGY ONLY</b></p>  <p><b>4PCS</b></p> <p>Off Road Pin Tyres</p>	<p><b>7204</b></p> <p><b>OFF ROAD BUGGY ONLY</b></p>  <p><b>4PCS</b></p> <p>Off Road Chrome Plated Rims</p>
<p><b>9201</b></p> <p><b>MONSTER TRUCK ONLY</b></p>  <p>Off Road Truck Body(Green)</p>	<p><b>9202</b></p> <p><b>MONSTER TRUCK ONLY</b></p>  <p>Off Road Truck Body(Blue)</p>	<p><b>9203</b></p> <p><b>MONSTER TRUCK ONLY</b></p>  <p>Off Road Truck Body(Yellow)</p>	<p><b>6528-B003</b></p> <p><b>OFF ROAD BUGGY ONLY</b></p>  <p>Off Road Buggy Body(Red+ White)</p>

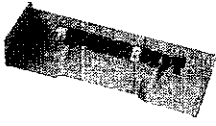
The images may vary from the actual received parts.

<p><b>6528-B004</b> OFF ROAD BUGGY ONLY</p>  <p>Installed with 6528-B003 Off Road Buggy Wing (Red)</p>	<p><b>6528-B005</b> OFF ROAD BUGGY ONLY</p>  <p>Off Road Buggy Body (Yellow+ Gray)</p>	<p><b>6528-B006</b> OFF ROAD BUGGY ONLY</p>  <p>Installed with 6528-B005 Off Road Buggy Wing (Yellow)</p>	
---	---	---	--

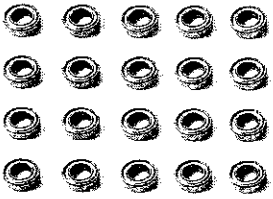
**OPTIONAL PARTS**

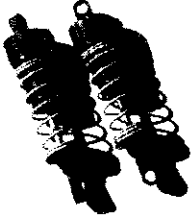
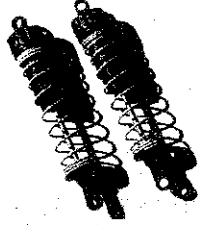
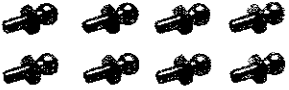
<p><b>4103</b></p>  <p>20PCS</p> <p>Ball Bearing 5*11*4</p>	<p><b>55801</b></p>  <p>TTTT</p> <p>Optional front/rear shock tower +Screws (Buggy)</p>	<p><b>55803</b></p>  <p>2PCS</p> <p>Front Oil filled shocks (Buggy)</p>	<p><b>55804</b></p>  <p>2PCS</p> <p>Rear Oil filled shocks (Buggy) Front/rear oil filled shocks (Monster truck)</p>
<p><b>H013</b></p>  <p>8PCS</p> <p><i>It is applied for 55804 installed on the monster truck</i></p> <p>Ball Stud <math>\Phi</math>4.8</p>			

**Tips:**  
If you want to install optional front/rear oil filled shocks (55803 and 55804), you must also purchase the optional front/rear tower (55801).

The images may vary from the actual received parts.

# PLASTIC ELEMENT PARTS

## A Spare Part Number: 1101

Chassis+ Chassis Guard

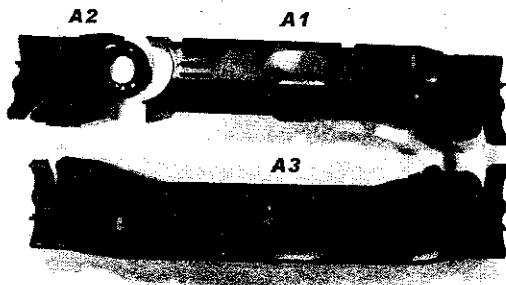

- A1. Chassis(left)
- A2. Chassis Guard
- A3. Chassis (right)

## B 1-14 Spare Part Number: 51820

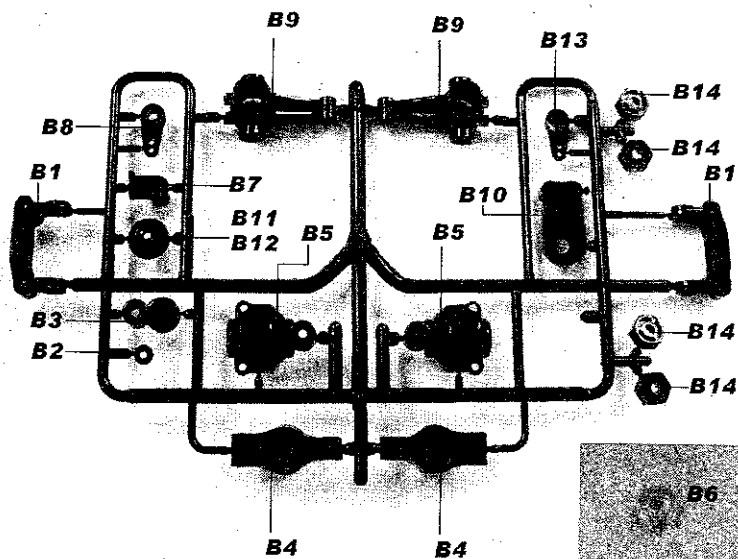

- B1. Front Uprights
- B2. Servo Mount Pad
- B3. Motor Pinion Guard
- B4. Rear Uprights
- B5. Gear Box Housing
- B6. Servo Saver
- B7. Antenna Retainer
- B8. Servo Arm
- B9. Steering Hubs
- B10. Servo Saver Assembly Set B
- B11. Servo Saver Assembly Set A
- B12. Servo Saver Assembly Set A(same as 11).
- B13. Servo Arm(same as 8)
- B14. Wheel Hex.

B6 not included in 51820

## C 1-21 Spare Part Number: 51803

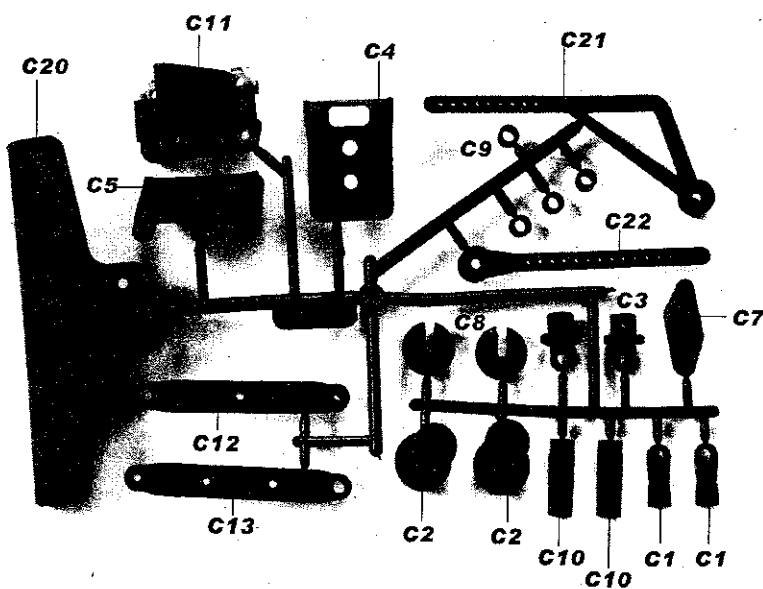

- C1. Shock Bottom Mount
- C2. Shock Body
- C3. Shock Upper Mount
- C4. Battery Retainer
- C5. Battery Cover
- C7. Motor Mount Plate
- C8. Shock Spring Holder
- C9. Shock Bush
- C10. Servo Mount
- C11. Front Bumper Mount
- C12. Front Upper Arm
- C13. Rear Upper Arm

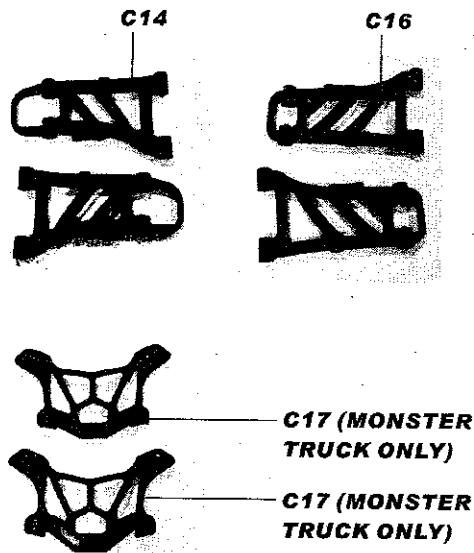

C14, C16, and C17 not included in 51803.

- C14. Front Lower Arm
- C16. Rear Lower Arm
- C17. Front/rear Shock Tower
- C20. Front/rear Bumper
- C21. Front Body Post
- C22. Rear Body Post



